



Special-Purpose Proximity Sensor

E2CA

Threaded Cylindrical Inductive Sensor with Separate Amplifier Provides Precision Linear Analog Output and a Discrimination Output

- Linear 4 to 20 mA output for target to sensor distance
- Position measurements accurate to ± 0.0006 mm with 0.05% full scale resolution
- Adjustable setpoint controls switching output rated 100 mA is NO/NC selectable
- Amplifier has power ON, target detected, and discrimination output indicators
- AC amplifier has universal voltage rating 90 to 264 VAC
- DC amplifier rated 10 to 30 VDC
- Sensors available in standard 8, 12, 18, 30 mm sizes with sensing distances up to 10 mm



Sensing	Supply voltage	Output	
 1.5, 2, 5, 10 mm	90 to 264 VAC, 50/60 Hz amplifier or 10 to 30 VDC amplifier	 4 to 20 mA	 100 mA, 40 VDC

Ordering Information

■ SENSOR

Sensor type		Shielded			
Part number	3 m (9.8 ft) cable	E2CA-X1R5A	E2CA-X2A	E2CA-X5A	E2CA-X10A
	5 m (16.4 ft) cable	E2CA-X1R5A-5M	E2CA-X2A-5M	E2CA-X5A-5M	E2CA-X10A-5M
Size		M8	M12	M18	M30
Nominal sensing distance		0.3 to 1.5 mm (0.01 to 0.06 in)	0.4 to 2.0 mm (0.02 to 0.08 in)	1 to 5 mm (0.04 to 0.20 in)	2 to 10 mm (0.08 to 0.39 in)

■ AMPLIFIER

Required sensor		E2CA-X1R5A/-5M	E2CA-X2A/-5M	E2CA-X5A/-5M	E2CA-X10A/-5M
Part number	AC power supply	E2CA-AN4C	E2CA-AN4D	E2CA-AN4E	E2CA-AN4F
	DC power supply	E2CA-AL4C	E2CA-AL4D	E2CA-AL4E	E2CA-AL4F
Outputs		Linear output, 4 to 20 mA; Switching output, selectable NO or NC transistor			

■ ACCESSORIES

Description		Part number
Mounting brackets for sensors	Fits M8 size sensors	Y92E-B8
	Fits M12 size sensors	Y92E-B12
	Fits M18 size sensors	Y92E-B18
	Fits M30 size sensors	Y92E-B30
Sockets for amplifiers	Combination bottom surface and track mounting socket with screw terminals	P2CF-11
	Back mounting socket with screw terminals for panel mount applications	P3GA-11
	Circuit board socket with solder terminals	PL-11

(This table continues on the following page.)

Specifications Table — continued from previous page

Description		Part number
Panel mounting adapter for amplifier		Y92F-30
Protective covers for amplifier	Hard plastic cover protects amplifiers from dust, dirt and water drip	Y92A-48
	Soft plastic cover protects amplifier from dust, dirt and water drip	Y92A-48D
Mounting track	DIN rail, 50 cm (1.64 ft) length	PFP-50N
	DIN rail, 1 m (3.28 ft) length	PFP-100N
	End plate	PFP-M
	Spacer	PFP-S

■ **REPLACEMENT PARTS**

Description		Part number
Mounting hardware includes one pair of metal nuts and washers	Fits M8 size sensors (supplied with each sensor)	M8-MHWS
	Fits M12 size sensors (supplied with each sensor)	M12-MHWS
	Fits M18 size sensors (supplied with each sensor)	M18-MHWS
	Fits M30 size sensors (supplied with each sensor)	M30-MHWS

Specifications

■ **SENSOR**

Part number		E2CA-X1R5A/-5M	E2CA-X2A/-5M	E2CA-X5A/-5M	E2CA-X10A/-5M
Sensor type		Inductive			
Body	Size	M8	M12	M18	M30
	Type	Shielded			
Required amplifier		E2CA-AL4C or E2CA-AN4C	E2CA-AL4D or E2CA-AN4D	E2CA-AL4E or E2CA-AN4E	E2CA-AL4F or E2CA-AN4F
Detectable object type		Metallic objects			
Effective maximum sensing distance (with standard target)		1.5 mm (0.06 in)	2 mm (0.08 in)	5 mm (0.20 in)	10 mm (0.39 in)
Usable sensing range (with standard target)		0.3 to 1.5 mm (0.01 to 0.06 in)	0.4 to 2.0 mm (0.02 to 0.08 in)	1 to 5 mm (0.04 to 0.20 in)	2 to 10 mm (0.08 to 0.39 in)
Standard target size (mild steel, L x W x H)		8 x 8 x 1 mm (0.32 x 0.32 x 0.04 in)	12 x 12 x 1 mm (0.47 x 0.47 x 0.04 in)	18 x 18 x 1 mm (0.71 x 0.71 x 0.04 in)	30 x 30 x 1 mm (1.18 x 1.18 x 0.04 in)
Response frequency		10 kHz		5 kHz	3 kHz
Indicators		Not provided			
Materials	Housing	Nickel-plated brass			
	Sensing face	Plastic, acrylonitril butadiene styrene			
	Cable sheath	Plastic, polyethylene			
Mounting		Two lock washers and M8 nuts included. Bracket Y92E-B8 optional.	Two lock washers and M12 nuts included. Bracket Y92E-B12 optional.	Two lock washers and M18 nuts included. Bracket Y92E-B18 optional.	Two lock washers and M30 nuts included. Bracket Y92E-B30 optional.
Connections	Prewired	2-conductor shielded cable: 3 m (9.8 ft) length (E2CA-X□□□A) 5 m (16.4 ft) length (E2CA-X□□□A-5M)			
Weight with cable		40 g (1.4 oz.)	60 g (2.1 oz.)	140 g (5.0 oz.)	160 g (5.7 oz.)
Enclosure ratings	UL	—			
	NEMA	1, 4, 6, 12, 13			
	IEC 144	IP67			
Approvals	UL	—			
	CSA	—			
Ambient operating temperature		-25° to 70°C (-13° to 158° F)			-10° to 55°C (14° to 131°F)
Vibration		10 to 55 Hz, 1.5 mm (0.06 in) double amplitude			10 to 25 Hz, 2 mm (0.08 in) double amplitude
Shock		Approx. 50 G			Approx. 10 G

■ **AMPLIFIER**

Part number		E2CA-A□4C	E2CA-A□4D	E2CA-A□4E	E2CA-A□4F	
Supply voltage	AC types	90 to 264 VAC, 50/60 Hz (E2CA-AN4□)				
	DC types	10 to 30 VDC (E2CA-AL4□)				
Current consumption	AC types	60 mA max. (E2CA-AN4□)				
	DC types	70 mA max. (E2CA-AL4□)				
Required sensor		E2CA-X1R5A	E2CA-X2A	E2CA-X5A	E2CA-X10A	
Linear output characteristics	Output range	4 to 20 mA				
	Resolution	0.05% to full scale				
	Linearity	± 2.0% of full scale	± 1.5% of full scale		± 2.0% of full scale	
	Response frequency	10 kHz		5 kHz	3 kHz	
	Adjustment	4 mA	Adjustment to 4 mA at 20% of effective maximum detecting distance			
		20 mA	Adjustment to 20 mA at effective maximum detecting distance			
Switching output characteristics	Operation mode	NO or NC, switch selectable				
	Detecting distance sensitivity	Adjustable (within sensor's "Usable Detecting Range")				
	Differential travel	Fixed, 1 to 5% of detecting distance				
	Control output	Type	Transistor, SPST			
		Max. load	100 mA, 40 VDC			
		Max. on-state voltage drop	2 VDC			
Response frequency	3 kHz		1.5 kHz	1 kHz		
Circuit protection	Switching output short-circuit	Not provided				
	DC power supply reverse polarity	Provided				
	Weld-field immunity	Not provided				
	RFI immunity	Not provided				
Indicators		Power ON (POWER), Linear Range (SPAN), and Switching Output ON (OPER)				
Materials	Housing	Plastic				
Mounting		Requires P2CF-11, P3GA-11 or PL11 sockets (not included); order separately from Accessories. Adapter Y92F-30 for panel mounting the amplifier (optional); order separately from Accessories.				
Connections		Plated steel screw terminals (P2CF-11 and P3GA-11 sockets); Solder terminals (PL11 socket)				
Weight without socket	AC types	250 g (8.8 oz.)				
	DC types	120 g (4.2 oz.)				
Enclosure ratings	UL	—				
	NEMA	1				
	IEC 144	IP40				
Approvals	UL	—				
	CSA	—				
Ambient operating temperature		-10° to 55°C (-14° to 131°F)				
Vibration		10 to 25 Hz, 2 mm (0.08 in) double amplitude				
Shock		Approx. 10 G				

Nomenclature

■ AMPLIFIER

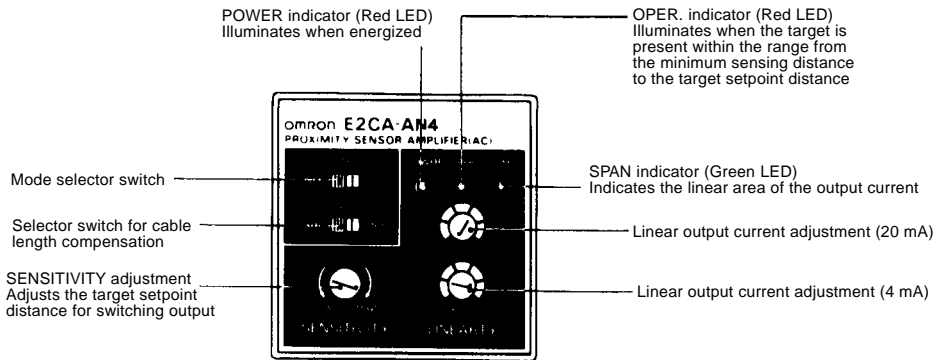

Operation

■ FUNCTION — AMPLIFIER

Classification		Function
OUTPUT	Linear output	An analog 4 to 20 mA output signal proportional to the distance from the target to the face of the sensor within the range of the 4 mA linear setpoint to the 20 mA setpoint.
	Switching output	A 100 mA, 40 VDC rated transistor output (separate power source required) adjustable within the range of the 4 mA linear setpoint and 20 mA linear setpoint.
INDICATORS	Power ON	Red LED illuminated when amplifier is connected to power source and energized.
	Operation	Red LED illuminated when the target is present within the range from the minimum sensing distance to the target setpoint distance.
	Span	Green LED illuminated when the target is present within the range of the 4 mA linear setpoint and the 20 mA linear setpoint.
ADJUSTMENTS	Cable length selector switch	Set to the length of cable (3 or 5 meters) supplied on the sensor head.
	4 mA linear adjustment	Used to set the analog output at 4 mA when the target is at 20% of the rated sensing distance. Adjustment method 1.
	20 mA linear adjustment	Used to set the analog output at 20 mA when the target is at 100% of the rated sensing distance. Adjustment method 1.
	Sensitivity	Used to set the target distance that turns on the switching output.
	Mode selector switch	Determines the logic of the switching output circuit. In the NO position, the target turns on when the target is present between the minimum sensing distance and the target setpoint distance. In the NC position, the switching output turns on when the target is beyond the target setpoint distance.

■ TIMING CHART

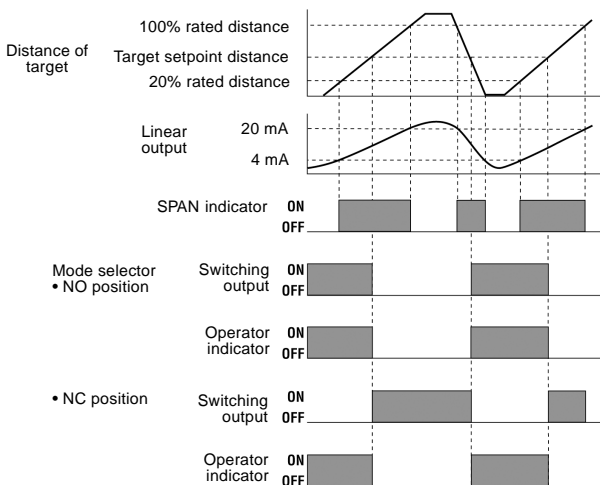

LINEAR OUTPUT ADJUSTMENTS

Choose one of the two adjustment methods for setting the LINEARITY adjuster. Adjustment of the 4 mA and 20 mA LINEARITY adjusters must be performed with the standard target at positions of 20% and 100% of the rated detecting distance away from the sensor.

Linearity Adjustment Method 1

1. Connect an ammeter across terminals 1 and 2. The illustration shows the sensor connected to an amplifier through socket P2CF-11.

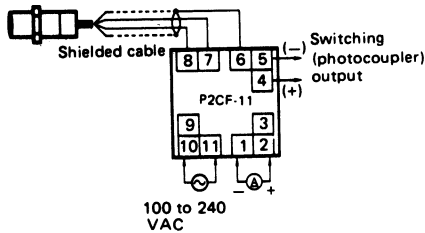

2. Place the standard target at 20% of the rated detecting distance away from the sensor unit.

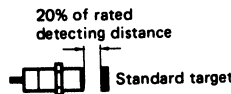

3. Turn the 4 mA LINEARITY adjuster slowly clockwise (to increase the output current) or counterclockwise (to decrease the output current). Set the adjuster to a position that reads 4 mA output on the ammeter.



4. Place the standard target at the rated detecting distance.

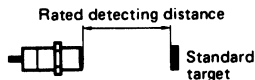

5. Turn the 20 mA LINEARITY adjuster slowly clockwise (to increase the output current) or counterclockwise (to decrease the output current). Set the adjuster to a position that reads 20 mA output on the ammeter.



6. To fine tune the adjustment accuracy of the output current, repeat the adjustment steps for 4 mA and 20 mA LINEARITY adjusters.

Linearity Adjustment Method 2

1. Set the standard target at 20% of the rated detecting distance away from the sensor.

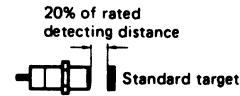

2. Turn the 4 mA LINEARITY adjuster counterclockwise so that the SPAN indicator remains OFF. Then slowly turn the adjuster clockwise until the indicator illuminates. Stop turning the adjuster at the position where the SPAN indicator illuminates.



3. Set the standard target at the rated detecting distance away from the sensor.

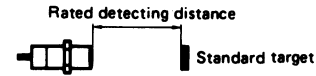

4. Slowly turn the 20 mA LINEARITY adjuster clockwise until the SPAN indicator goes OFF. Then turn the adjuster counterclockwise until the indicator illuminates. Stop turning the adjuster when the SPAN indicator illuminates.



SENSITIVITY ADJUSTMENTS

Place the standard target at the specified position. If the target moves in parallel with the surface of the sensor unit, make the adjustment after determining the position using the following procedure.

1. Adjust the linear output according to Adjustment Method 1 or 2.



2. Calculate detecting distance X using the following formula:

$$X = \frac{S}{0.8} \quad S = \text{setting distance}$$

3. Adjust the distance between the sensor and the object to be detected to distance X.



Slowly turn the SENSITIVITY adjuster clockwise (toward HIGH) and stop turning when the OPER. indicator illuminates. Move the target to confirm that the OPER. indicator illuminates when the object to be detected is at the specified position and that the indicator goes OFF when the target is moved away from that position.

If the target moves in parallel with the surface of the sensor unit, place the sensor at distance S.

■ **SELECTOR SWITCHES**

Selection of Operation Modes

OUTPUT NO <input type="checkbox"/> NC	The output transistor turns ON when the target is detected.
OUTPUT NO <input checked="" type="checkbox"/> NC	The output transistor turns ON when the target is not being detected.

Compensation for Different Cable Lengths

Set the CABLE selector switch to the required position according to the length of the sensor cable being used: 3 m (9.8 ft) or 5 m (16.4 ft).

CABLE 3 m <input type="checkbox"/> 5 m	To use sensors with 3 m (9.8 ft) cable length.
CABLE 3 m <input checked="" type="checkbox"/> 5 m	To use sensors with 5 m (16.4 ft) cable length.

Dimensions

Unit: mm (inch)

■ **SENSORS**

M8 Size

E2CA-X1R5A, E2CA-X1R5A-5M

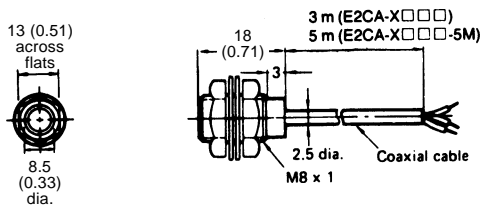

M12 Size

E2CA-X2A, E2CA-X2A-5M

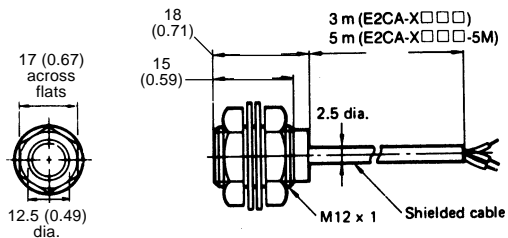

M18 Size

E2CA-X5A, E2CA-X5A-5M

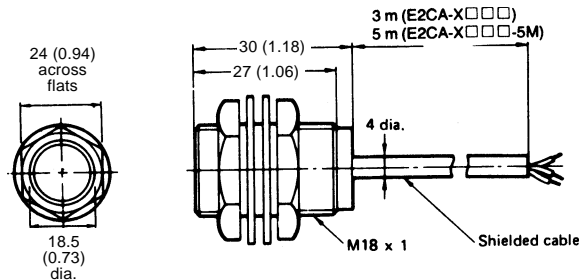

M30 Size

E2CA-X10A, E2CA-X10A-5M

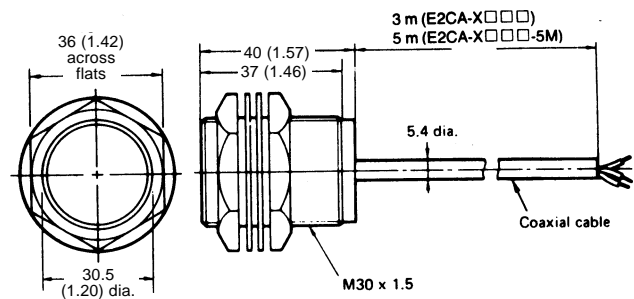

■ **AMPLIFIERS**

E2CA-AL4□, E2CA-AN4□

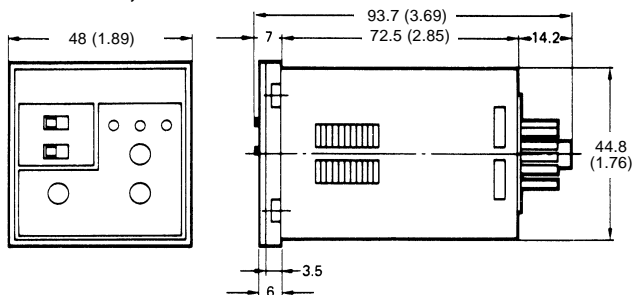

■ SOCKETS FOR AMPLIFIERS

P2CF-11 Track-Mount Socket with Screw Terminals

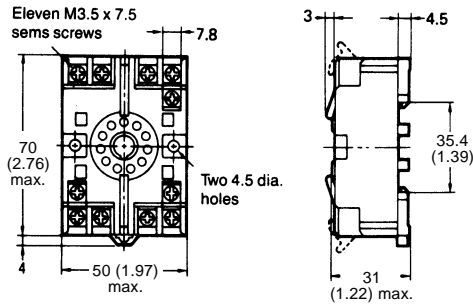

Terminal Arrangement (top view)

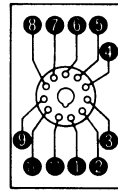

Mounting Holes

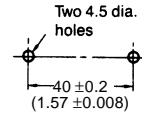

Note: The socket can be mounted on DIN rail track or surface mounted using two through holes.

P3GA-11 Back-Mounting Socket with Screw Terminals

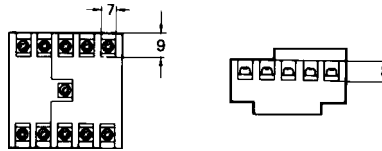
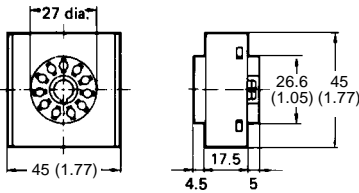

Terminal Arrangement (bottom view)

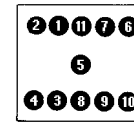

PL11 Circuit Board Socket with Solder Terminals

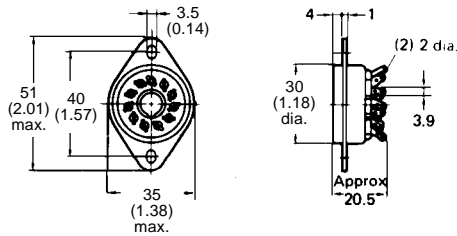

Terminal Arrangement (bottom view)

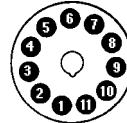

Mounting Holes

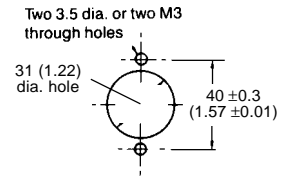

■ MOUNTING TRACK AND ACCESSORIES

PFP-100N/PFP-50N DIN Rail Track

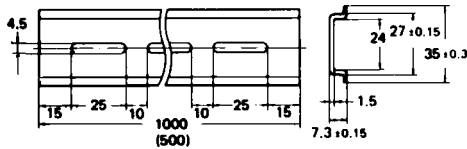

PFP-M End Plate

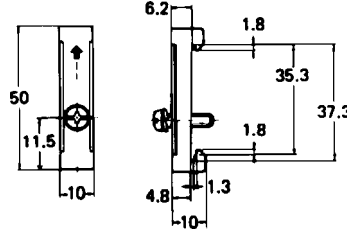

PFP-S Spacer

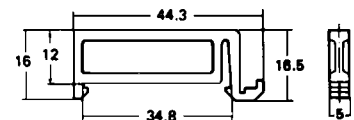

■ Y92A-48, Y92A-48D OPTIONAL PROTECTIVE COVERS FOR AMPLIFIERS

Hard plastic cover Y92-48 and soft plastic cover Y92A-48D snap onto the front of the amplifier to protect it from dust, dirt and water drip. The Y92A-48 hard plastic cover projects 4 mm from the front of the amplifier. Y92A-48D soft plastic cover fits snugly over the front.

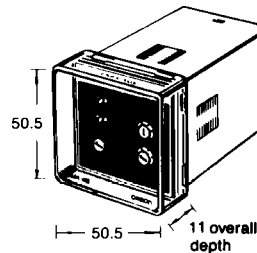

■ Y92F-30 OPTIONAL PANEL MOUNTING ADAPTER FOR AMPLIFIERS

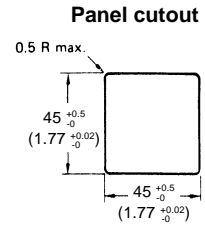
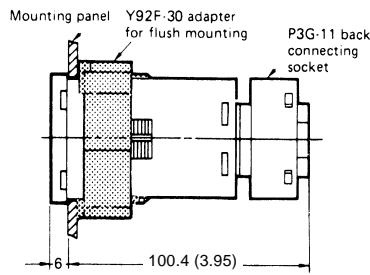
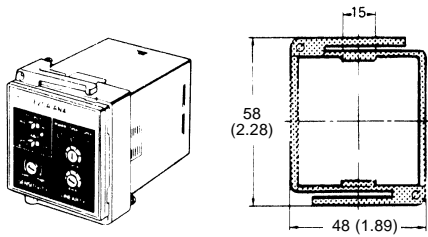

Note: Recommended panel thickness is 1 to 3.2 mm.

■ OPTIONAL MOUNTING BRACKETS FOR SENSORS

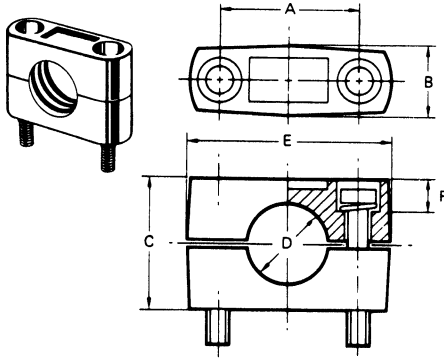

Part number	Drawing dimension						Applicable sensor models
	A	B	C	D	E	F	
Y92E-B8	18±0.2	10 max.	18	8 dia.	28 max.	M4 x 20 bolt	E2CA-X1R5A, E2CA-X1R5A-5M
Y92E-B12	24±0.2	12.5 max.	20	12 dia.	37 max.	M4 x 25 bolt	E2CA-X2A, E2CA-X2A-5M
Y92E-B18	32±0.2	17 max.	30	18 dia.	47 max.	M5 x 32 bolt	E2CA-X5A, E2CA-X5A-5M
Y92E-B30	45±0.2	17 max.	50	30 dia.	60 max.	M5 x 50 bolt	E2CA-X10A, E2CA-X10A-5M

Engineering Data

■ OPERATING DISTANCE VS. OUTPUT CURRENT

M8 Size Sensor
E2CA-X1R5A

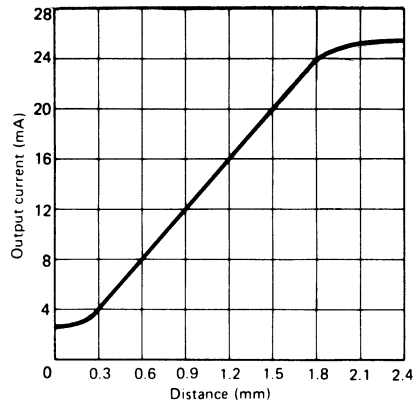

M12 Size Sensor
E2CA-X2A

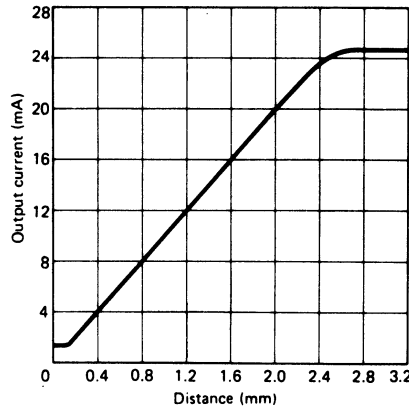

M18 Size Sensor
E2CA-X5A

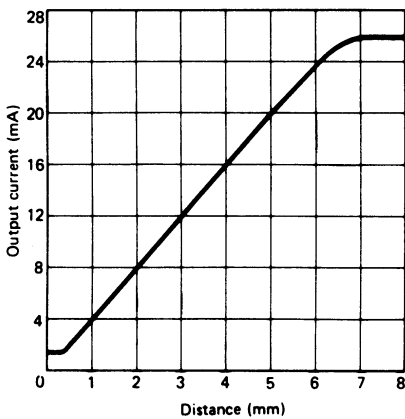

M30 Size Sensor
E2CA-X10A

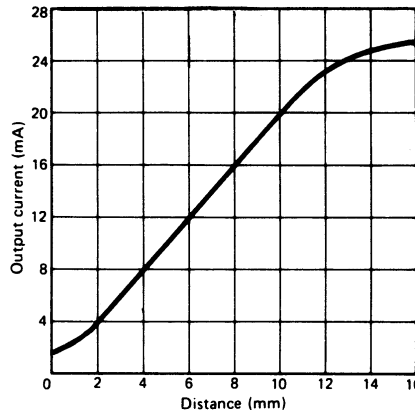

■ DETECTING DISTANCE VS. LINEARITY (SQUARE AND RECTANGULAR OBJECTS)

M8 Size Sensor
E2CA-X1R5A

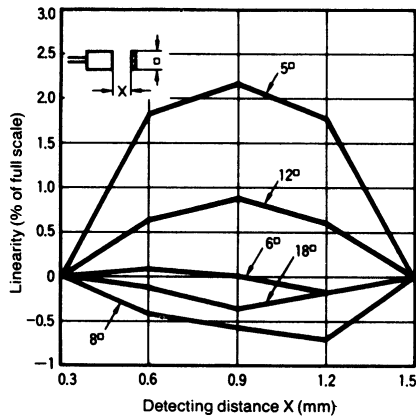

M12 Size Sensor
E2CA-X2A

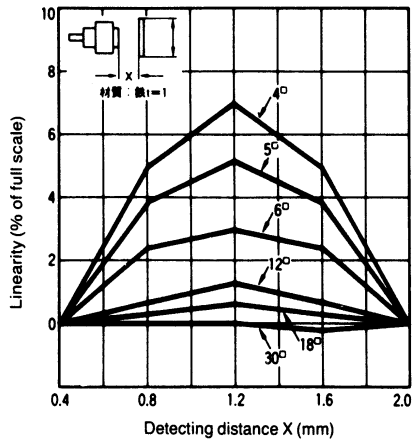

M18 Size Sensor
E2CA-X5A

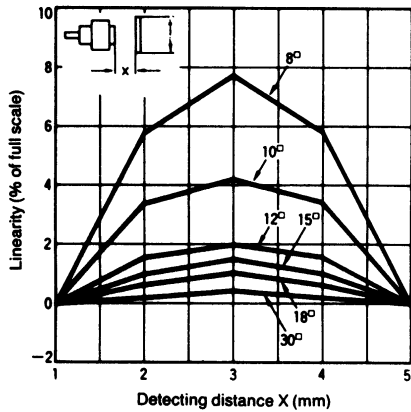

M30 Size Sensor
E2CA-X10A

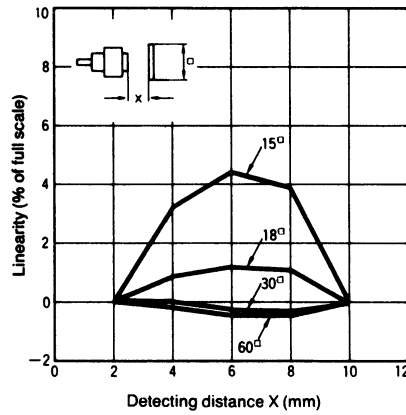

■ DETECTING DISTANCE VS. LINEARITY (CYLINDRICAL OBJECTS)

M8 Size Sensor
E2CA-X1R5A

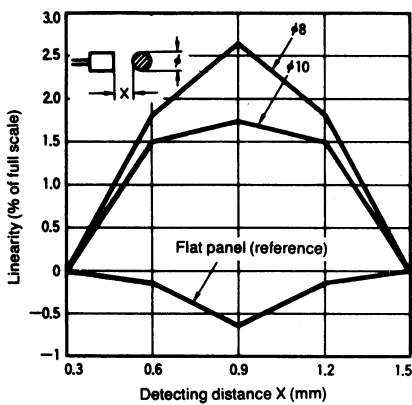

M12 Size Sensor
E2CA-X2A

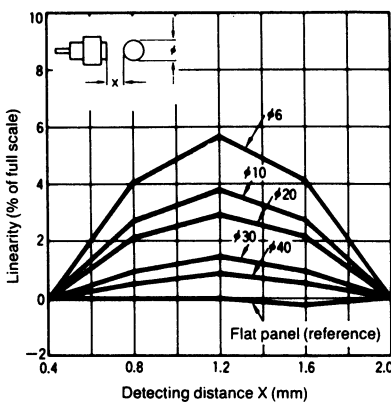

M18 Size Sensor
E2CA-X5A

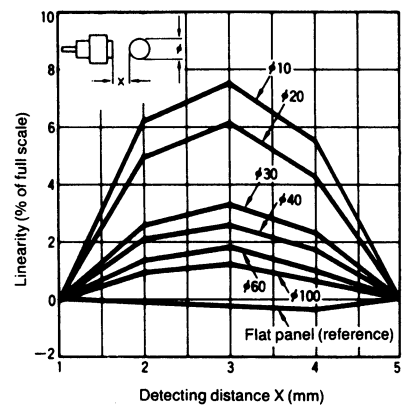

Installation

OUTPUT CIRCUIT DIAGRAM

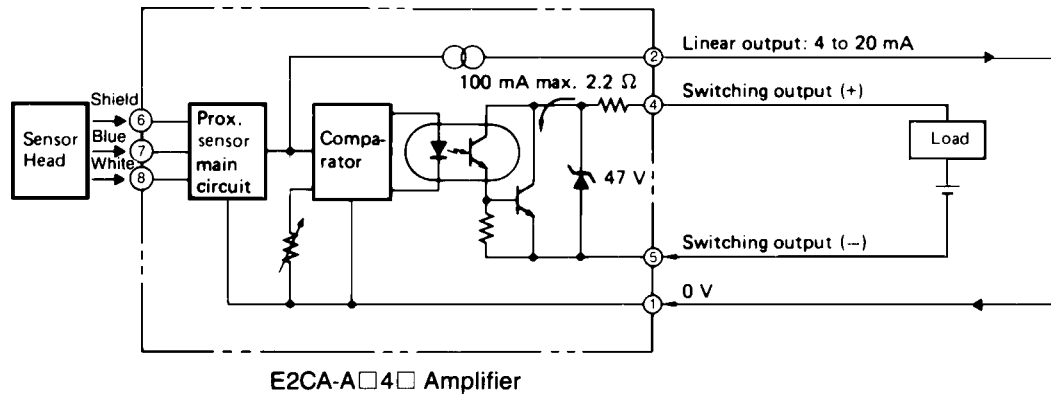

CONNECTIONS BETWEEN SENSOR AND AMPLIFIER

Note: The illustrations show the terminal arrangement viewed from the rear of the socket that is coupled to the amplifier.

DC Amplifier and Sensor

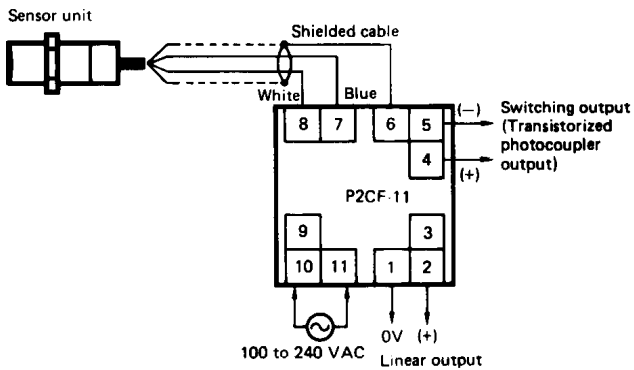

AC Amplifier and Sensor

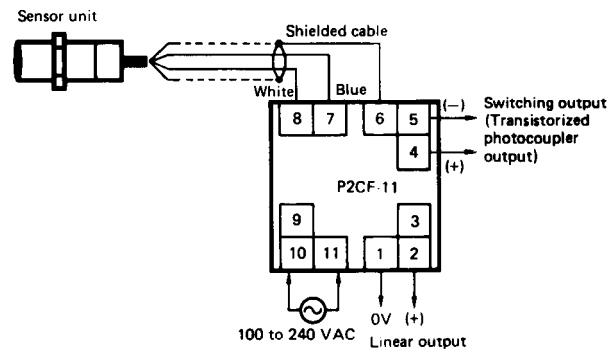

CONNECTION OF LINEAR OUTPUT

Note: The illustration shows the linear output connected to a resistive load.

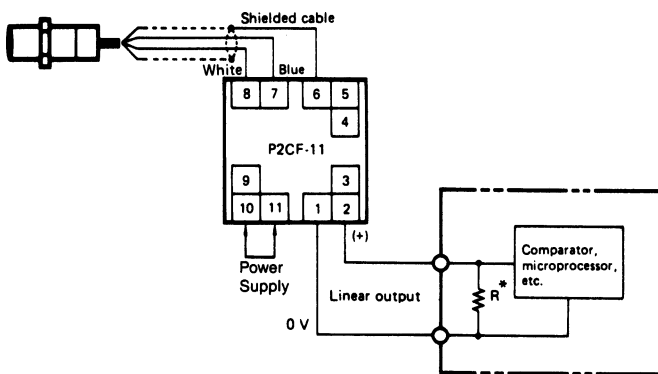

* Resistance R when E2CA-AL4 is used: 300 Ω max. at 24 V/150 Ω max. at 12 V
Resistance R when E2CA-AN4 is used: 300 Ω max.

■ CONNECTION OF SWITCHING OUTPUT

A transistorized photocoupler output is used for the switching output of the E2CA-A□4□ amplifier unit, which offers flexibility for switching different loads and power supply polarity selection.

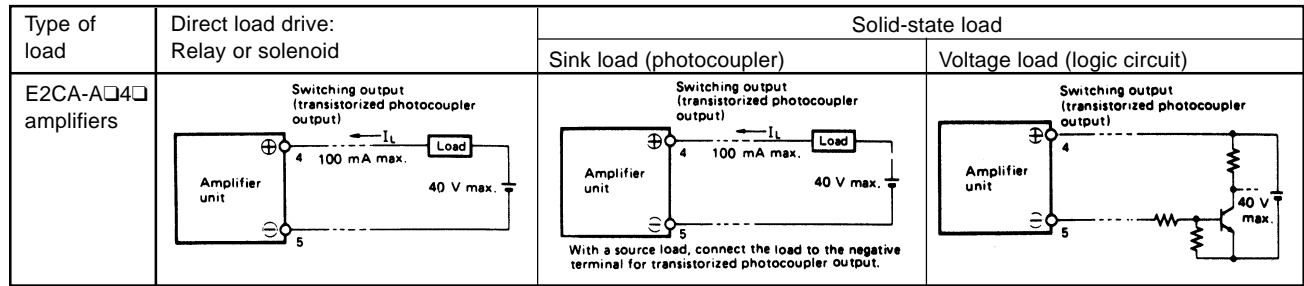

■ MOUNTING SENSORS

Effects of Surrounding Metals

Shielded E2CA proximity sensors may be mounted flush with a metallic panel. Be sure to provide a minimum distance as shown in the table to prevent the sensor from being affected by metallic objects other than the target.

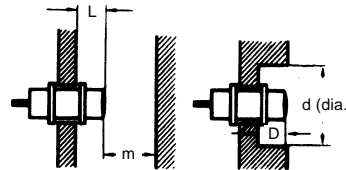

Drawing dimension	Sensor model							
	E2CA-X1R5A		E2CA-X2A		E2CA-X5A		E2CA-X10A	
	mm	inch	mm	inch	mm	inch	mm	inch
L	0	0	0	0	0	0	0	0
d (dia.)	8	0.32	12	0.47	18	0.71	30	1.18
D	0	0	0	0	0	0	0	0
m	4.5	0.18	6	0.24	15	0.59	30	1.18

Mutual Interference

To prevent mutual interference between two sensors, be sure to space the two sensors at a distance greater than that shown in the table.

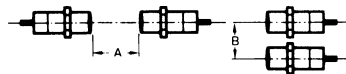

Drawing dimension	Sensor model							
	E2CA-X1R5A		E2CA-X2A		E2CA-X5A		E2CA-X10A	
	mm	inch	mm	inch	mm	inch	mm	inch
A	20	0.79	30	1.18	50	1.97	100	3.94
B	15	0.59	20	0.79	35	1.38	70	2.76

Tightening Force

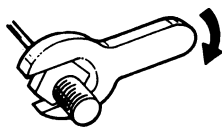

Do not exceed the maximum torque listed in the table.

Sensor model	Maximum torque	
	kg-cm	in-lbs
E2CA-X1R5A	20	17
E2CA-X2A	60	52
E2CA-X5A	150	130
E2CA-X10A	400	346

■ MOUNTING AMPLIFIERS

Track-Mount Installation Using P2CF-11 Socket

The P2CF-11 socket has two hooks that secure the E2CA amplifier to the socket. Be sure to allow at least 20 mm (0.79 in) clearance above and below the socket to gain access and to release the hooks for servicing and maintenance. The P2CF-11 socket may also be used for surface mounting the amplifier using the two through holes.

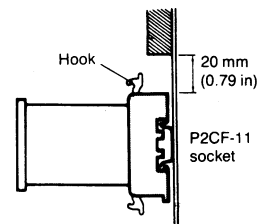

Panel-Mount Installation Using Y92F-30 Adapter and P3GA-11 Socket

Insert the E2CA amplifier through the panel cutout. Push the Y92F-30 adapter from the rear of the amplifier as far forward toward the panel as possible. Then tighten the two retaining screws. Wire the P3GA-11 socket, then push it onto the rear of the amplifier. To release the adapter, lift the tab at the rear of the adapter.

Several E2CA amplifiers may be panel mounted close together using Y92F-30 adapter as shown here. When mounting two or more amplifiers in a vertical line, arrange the adapters so that their molded tabs are positioned on the right and left sides. When mounting two or more amplifiers in a horizontal line, arrange the adapters so that their molded tabs are positioned on the top and bottom sides.

Panel Cutout for Side-by-Side Mounting of Two Amplifiers

NOTE: DIMENSIONS ARE SHOWN IN MILLIMETERS. To convert millimeters to inches divide by 25.4.

OMRON ELECTRONICS LLC.
One East Commerce Drive
Schaumburg, IL 60173
1-800-55-OMRON

OMRON ON-LINE
Global - <http://www.omron.com>
USA - <http://www.omron.com/oei>
Canada - <http://www.omron.com/oci>

OMRON CANADA, INC.
885 Milner Avenue
Scarborough, Ontario M1B 5V8
416-286-6465